

Designation	QUANTITÉ	DESCRIPTION	LONGUEUR
A1	1	tube carré 30 x 3	1000
A2	1	cornière 30 x 3	230
A3	1	tube rond 40 x 4	230
A4	2	fer plat 40 x 12	150

Outil	Démonte palette			
Date	01/03/2023	Version	page n° 2 / 2	
Feuille	Vue 2D + infos de construction			

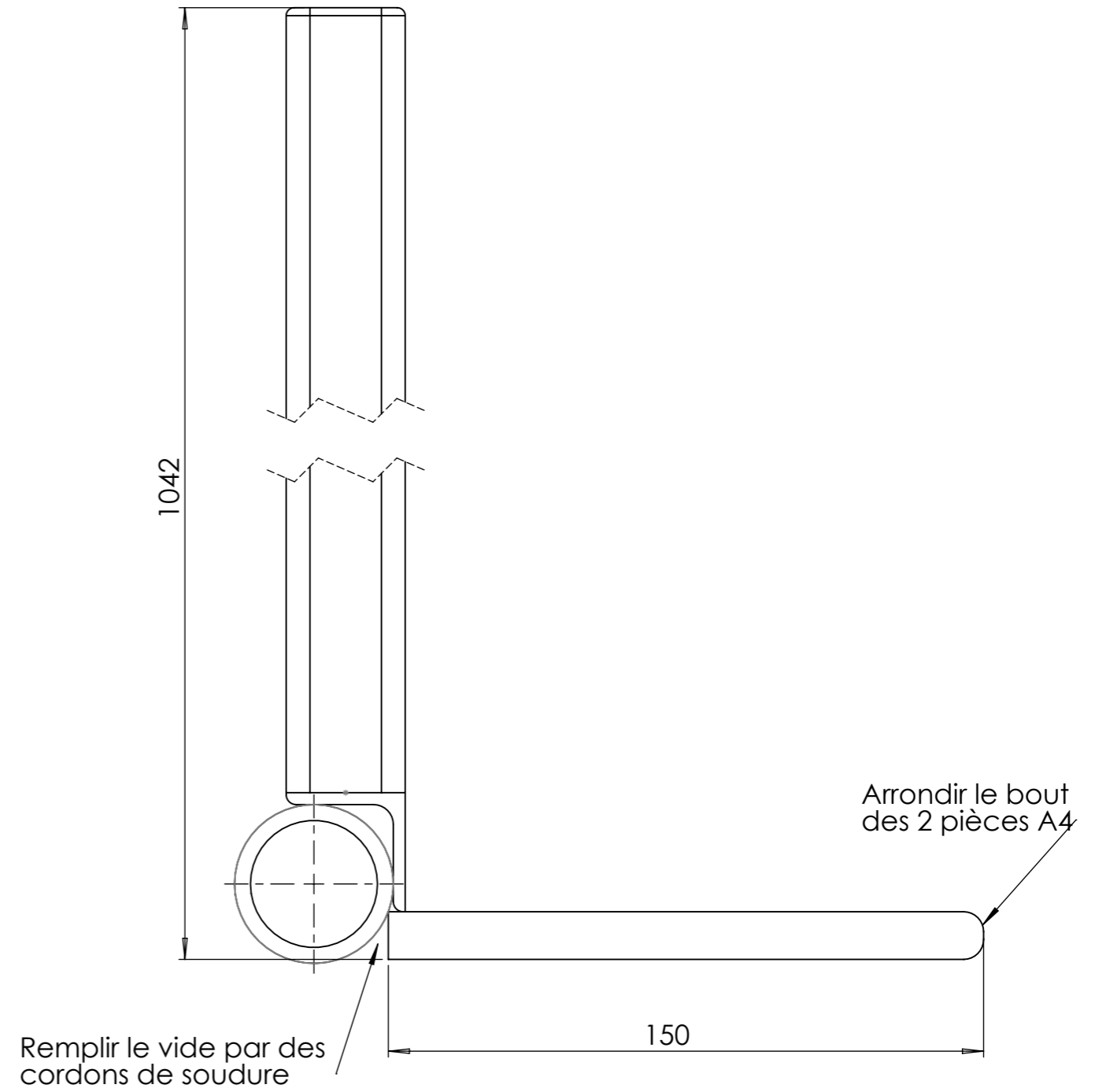

Meuler les 4 arrêtes pour plus de confort à l'utilisation

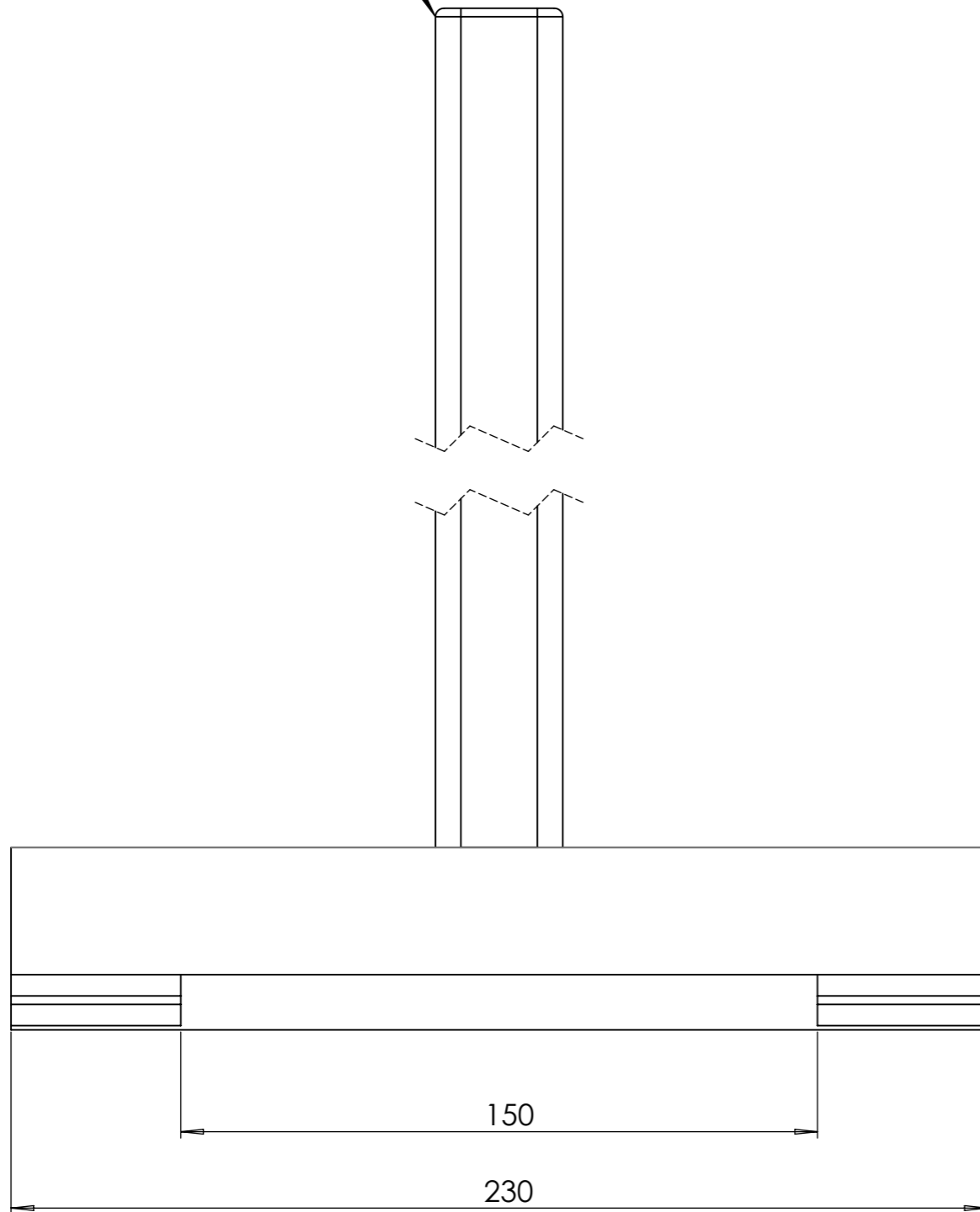

NOTE : Lors de l'assemblage, soudez partout ou cela est possible à l'électrode de 3.2mm.