

Outil	Semoir Viti				
Date	29/09/2017	Version	3.0		page n° 1 / 1
Pièce	C2 et C3		Qté		1

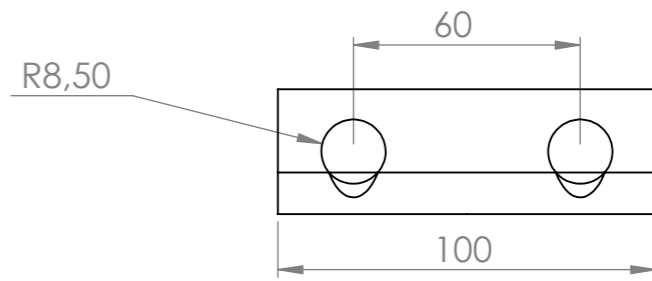

N°	Désignation	Qté
C2	U plié 27 x 27 lg 100	1

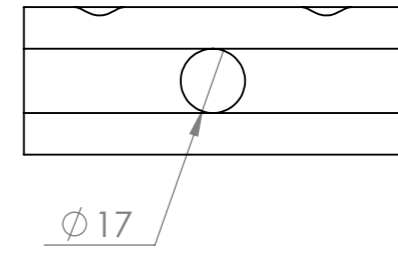
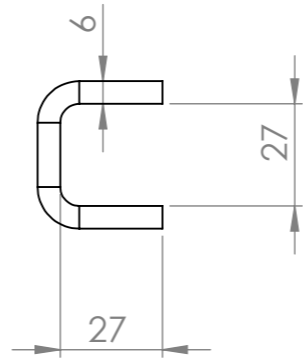
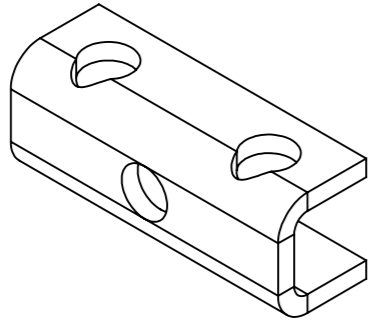
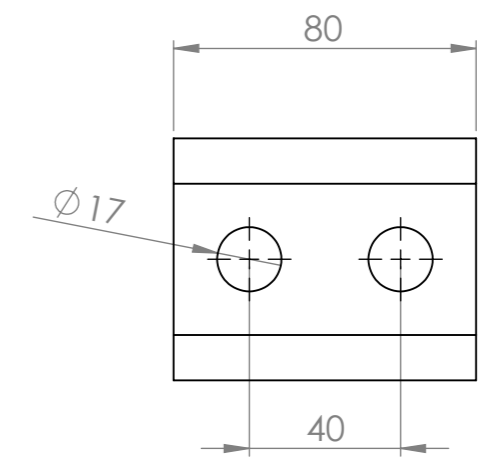
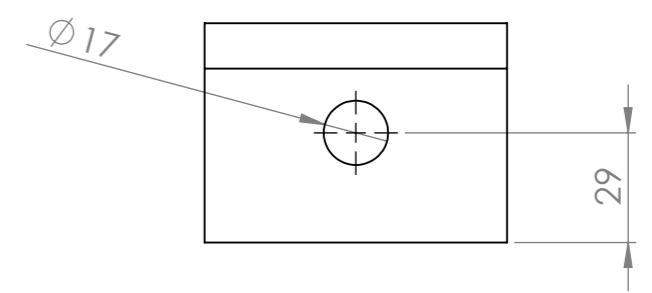
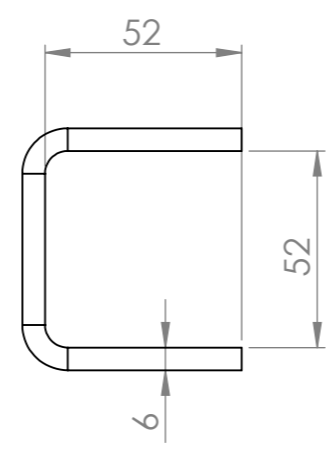
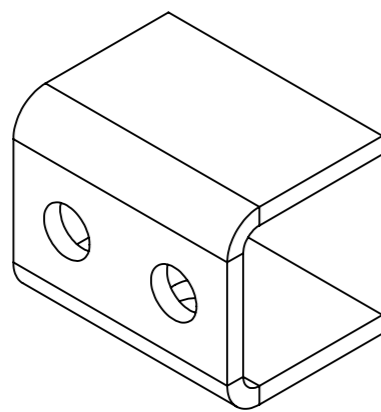

N°	Désignation	Qté
C3	U plié 52 x 52 lg 80	1