

Outil	SE2				
Date	02/09/2024	Version	1		page n° 1 / 1
Feuille	SE2				

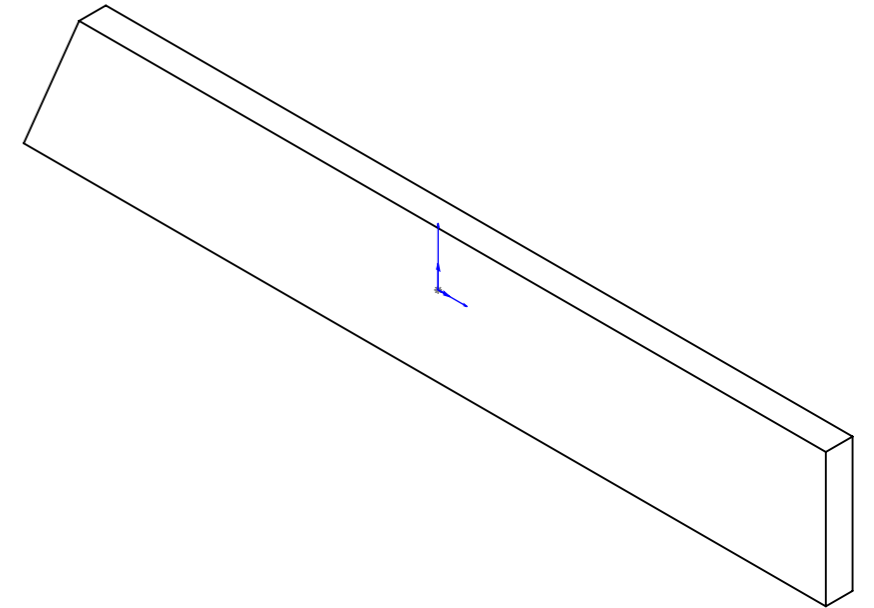

SE2
Acier S235

