



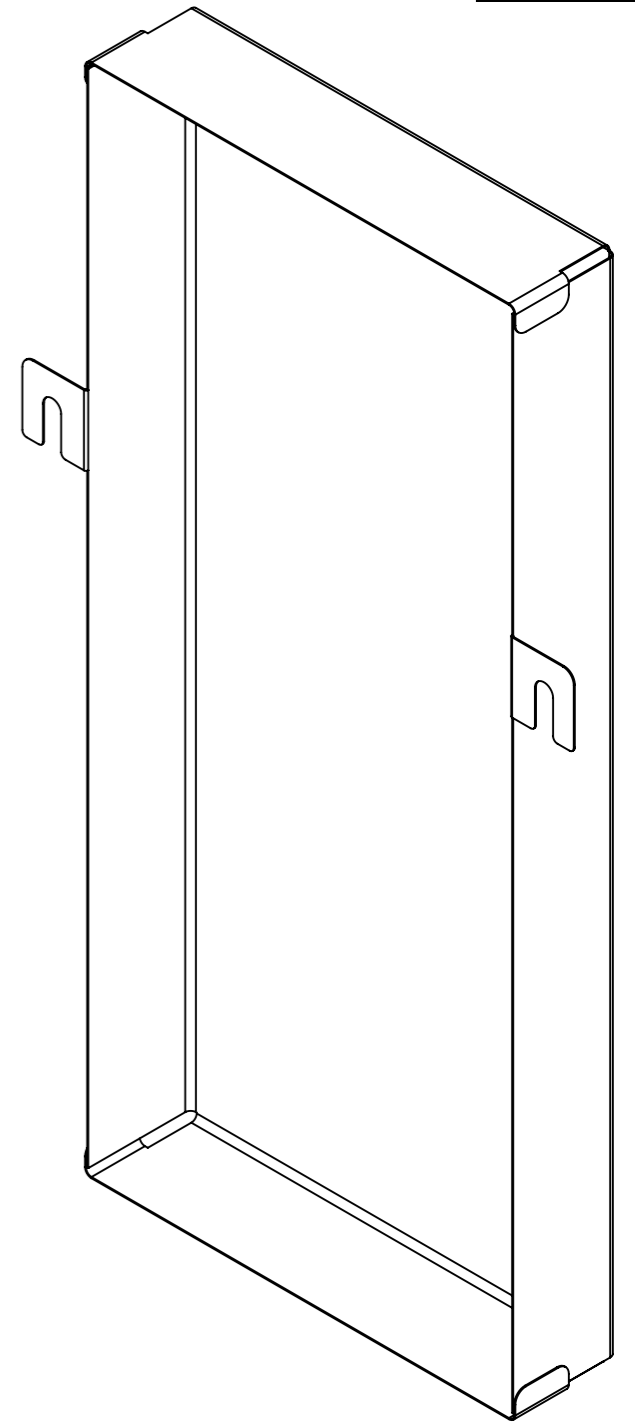

Date	21/09/2021	   			
Version	5.0				
Outil	Brosse à blé	Pièce	Carter corroies	Qté	1

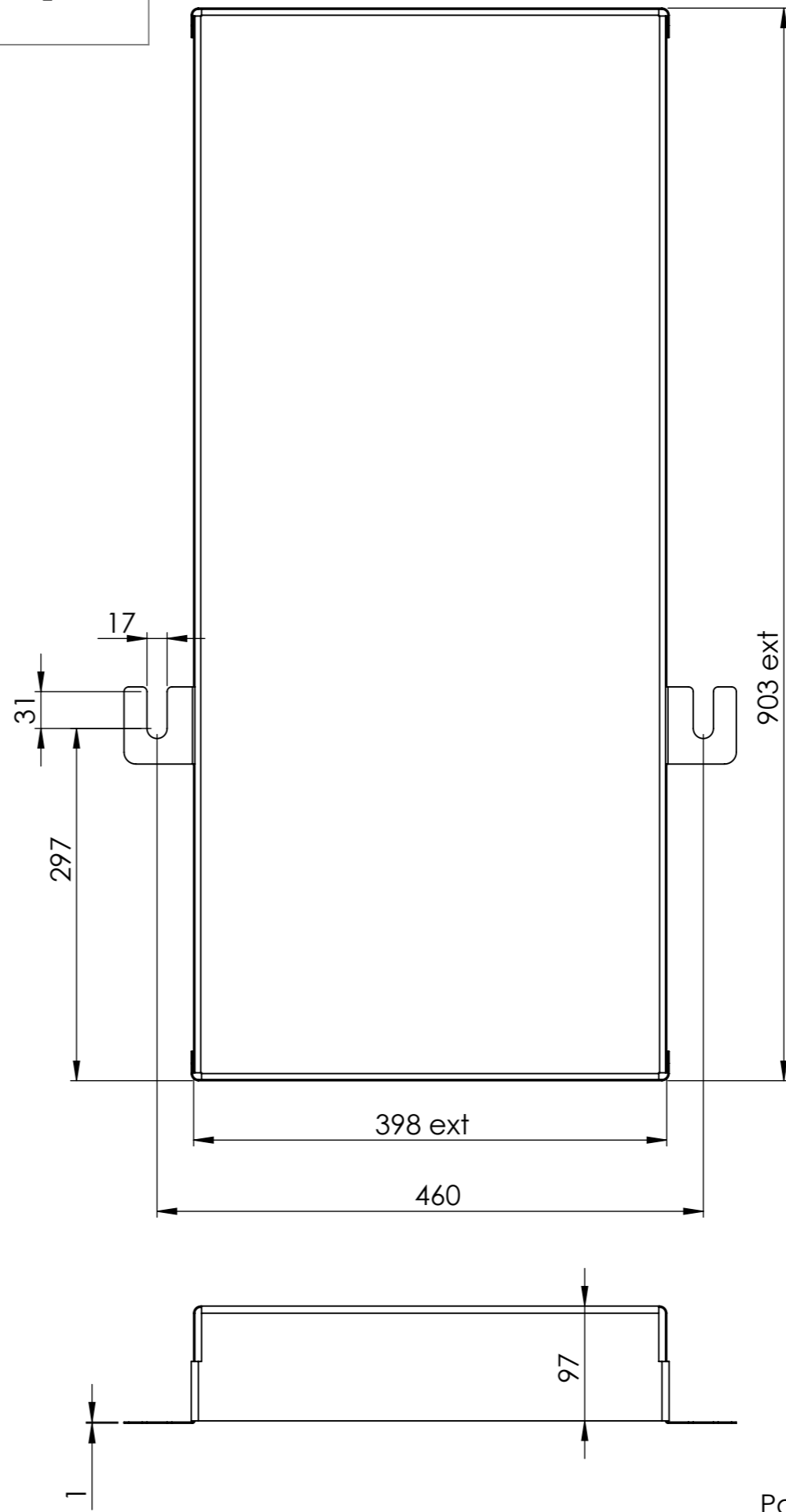
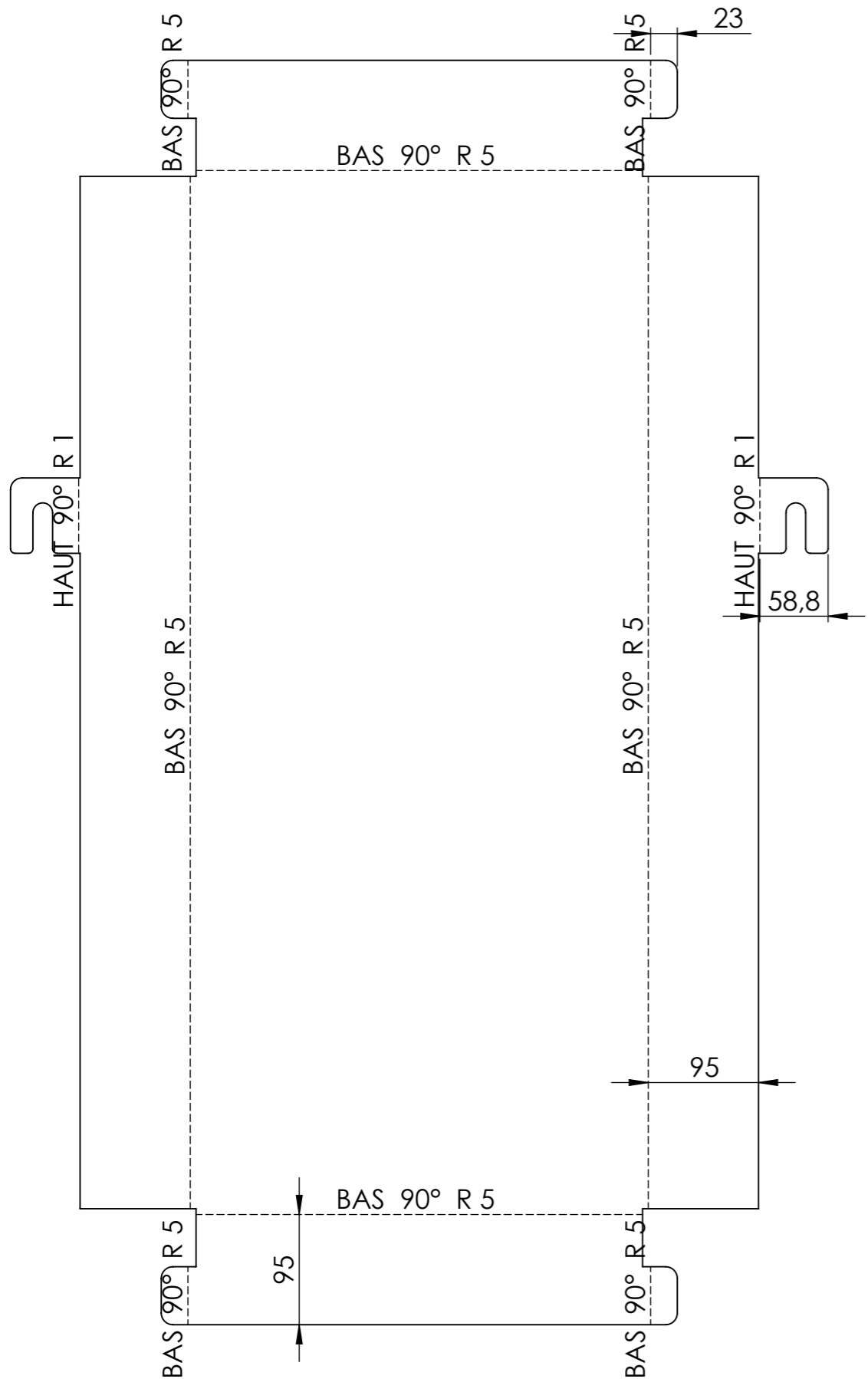

Ne nécessite pas une grande précision au pliage

Pour plus de rigidité, les coins peuvent être fermés avec un point de soudure ou un rivet.